

Quick Acting Couplings

Application

- Full flow coupling used on utility air, water, and nitrogen lines

Features

- Unisex design
- Spring-loaded interlocking engagement
- Corrosion resistant coating
- Smooth ID permits full flow path to tool
- Optional locking key prevents accidental sleeve retraction
- Interchangeable with Thor PHC-Series, National brands Series A, Dual-Lock, and Campbell double lock

Materials

- Machined components: solid steel, brass, or 303 stainless steel bar stock
- Steel couplings with zinc cast sleeve
- 1-piece sleeve retaining ring and spring: stainless steel
- 2-piece sleeve: phosphor bronze spring
- Componentry: steel-plated using ROHS Compliant Trivalent Chrome

Specifications

- Working pressure: **300 PSI**
- Operating temperature: **-40° to 250°F (-40° to 121°C)**
- Hose barb
- Male pipe thread
- Female pipe thread
- Locking sleeve
- Knurled flange sleeve

Connection

- Push and twist
- Locking clip (part # 4P-CLIP) is available to prevent unintentional disconnection

Disconnection

- Pull and twist
- Never attempt to disconnect any hose while pressure is in the line 

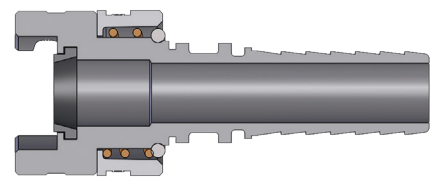
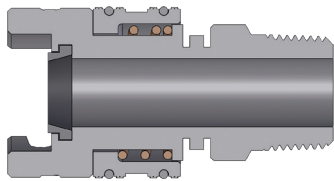

Safety

Dixon® couplings and retention devices are designed to work safely for their intended use. The selection of the proper hose, coupling and retention device, and the proper application of the coupling to the hose are of utmost importance.

Users must consider the size, temperature, application, media, pressure and hose and coupling manufacturer's recommendations when selecting the proper hose assembly components. Dixon recommends that all hose assemblies be tested in accordance with the Association for Rubber Products Manufacturer's (ARPM) recommendations and be inspected regularly (before each use) to ensure that they are not damaged or have become loose. Visit ARPMINC.com for more information.

Where safety devices are integral to the coupling, they must be working and utilized. The use of supplementary safety devices such as safety clips or safety cables are recommended.

If any problem is detected, couplings must be removed from service immediately.

Dixon is available to consult, train and recommend the proper selection and application of all fittings we sell. We strongly recommend that distributors and end users make use of Dixon Testing and Recommendation Services. Call 877.963.4966 or visit dixonvalve.com to learn more.

Quick Acting Couplings

Hose Barb with Locking Sleeve

Body Size	Hose Size	Plated Steel Part #	Brass Part #	Stainless Steel Part #
1/2"	3/8"	4PS3	---	---
1/2"	1/2"	4PS4	4PS4-B	---
1/2"	3/4"	4PS6	4PS6-B	4PS6-S
1/2"	1"	4PS8	4PS8-B	---

Dimensions

Size	A	B
3/8"	3.53"	1.55"
1/2"	3.95"	1.55"
3/4"	3.95"	1.55"
1"	6.06"	1.55"

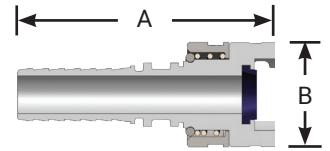

Male Pipe Thread with Locking Sleeve

Body Size	Threads	Plated Steel Part #	Stainless Steel Part #
1/2"	3/8"	4PM3	---
1/2"	1/2"	4PM4	---
1/2"	3/4"	4PM6	4PM6-S
1/2"	1"	4PM8	---

Dimensions

Size	Flat	A	B
3/8"	7/8"	2.93"	1.55"
1/2"	7/8"	2.94"	1.55"
3/4"	11/16"	2.98"	1.55"
1"	1-3/8"	3.11"	1.55"

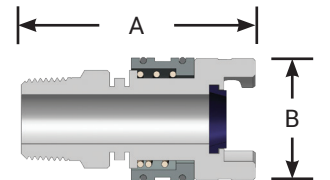

Female Pipe Thread with Locking Sleeve

Body Size	Threads	Plated Steel Part #	Brass Part #	Stainless Steel Part #
1/2"	1/2"	4PF4	---	---
1/2"	3/4"	4PF6	4PF6-B	4PF6-S

Dimensions

Size	Flat	A	B
1/2"	1-1/4"	2.75"	1.55"
3/4"	1-1/4"	2.75"	1.55"

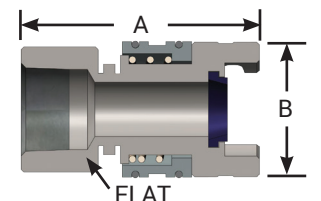

Quick Acting Couplings

Male Pipe Thread

Body Size	Threads	Plated Steel Part #	Brass Part #	Stainless Steel Part #
1/2"	3/8"	P4M3	---	---
1/2"	1/2"	P4M4	P4M4-B	---
1/2"	3/4"	P4M6	P4M6-B	P4M6-S
1/2"	1"	P4M8	P4M8-B	---

NOTE: Must be used with locking sleeve fittings above

Dimensions

Size	Flat	A	B
3/8"	7/8"	2.00"	1.55"
1/2"	15-16"	2.25"	1.55"
3/4"	1-1/2"	2.55"	1.55"
1"	1-3/8"	3.25"	1.55"

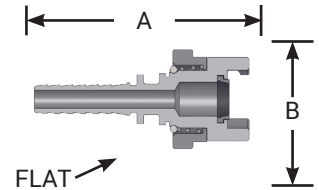
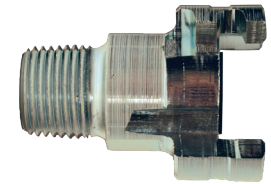

Female Pipe Thread

Body Size	Threads	Plated Steel Part #	Brass Part #	Stainless Steel Part #
1/2"	3/8"	P4F3	---	---
1/2"	1/2"	P4F4	P4F4-B	---
1/2"	3/4"	P4F6	P4F6-B	P4F6-S
1/2"	1"	P4F8	P4F8-B	---

NOTE: Must be used with locking sleeve fittings on page 3

Dimensions

Size	Flat	A	B
3/8"	7/8"	1.79"	1.55"
1/2"	1-5/16"	2.25"	1.55"
3/4"	1-5/16"	2.34"	1.55"
1"	1-7/16"	2.76"	1.55"

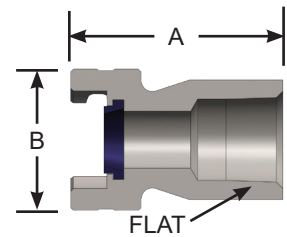
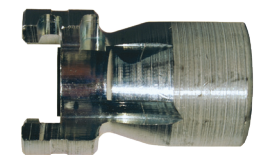

Hose Barb with Knurled Flanged Sleeve

Feature

- Large, raised collar sleeve permits easier handling when wearing gloves

Body Size	Hose Size	Plated Steel Part #
1/2"	3/8"	4PS3-FS
1/2"	1/2"	4PS4-FS
1/2"	3/4"	4PS6-FS

Dimensions

Size	A	B
3/8"	3.53"	1.81"
1/2"	3.95"	1.81"
3/4"	3.95"	1.81"

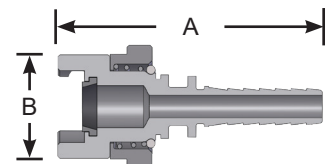

Quick Acting Couplings

Male Pipe Thread with Knurled Flanged Sleeve

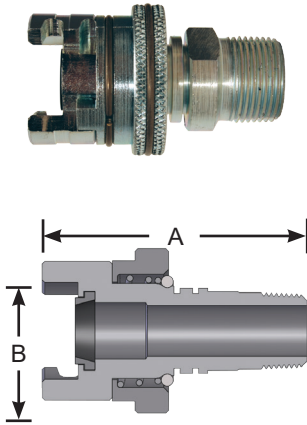

Feature

- Large, raised collar sleeve permits easier handling when wearing gloves

Body Size	Threads	Plated Steel Part #
1/2"	3/8"	4PM3-FS
1/2"	1/2"	4PM4-FS
1/2"	3/4"	4PM6-FS

Dimensions

Size	A	B
3/8"	2.93"	1.81"
1/2"	2.98"	1.81"
3/4"	2.98"	1.81"

Female Pipe Thread with Knurled Flanged Sleeve

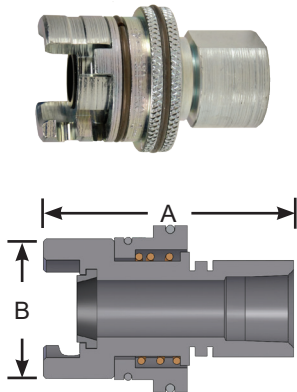

Feature

- Large, raised collar sleeve permits easier handling when wearing gloves

Body Size	Threads	Plated Steel Part #
1/2"	1/2"	4PF4-FS
1/2"	3/4"	4PF6-FS

Dimensions

Size	A	B
1/2"	2.75"	1.81"
3/4"	2.75"	1.81"

Sleeve Locking Key

Features

- Fits couplings with locking sleeve
- Prevents sleeve retraction



Part #	Description
4P-SKIT	Nitrile Rubber (standard)
F-4P-SKIT	FKM

Replacement Gaskets

Part #
4P-CLIP

Dual-Lock with Ferrule

Features

- Can be crimped
- Also available in brass and stainless steel



Sizes

- 3/8" and 1" sizes available upon request, contact Dixon®

Body Size	Hose Size	OD Range		Plated Steel Part #
		From:	To:	
1/2"	1/2"	54/64"	1-22/64"	4PS4-WF
1/2"	3/4"	1-10/64"	1-22/64"	4PS6-WF

Crimped Recommendation Guide

The chart below is only a guide. It will not apply to every coupling situation. In some instances, alternative dies and crimping dimensions must be employed to ensure safety. Experience has shown that variances in the construction of similar hoses and couplings may cause some assemblies to react differently when crimped. It is not uncommon to find hose with an outer diameter that fluctuates from one end to the other or from production lot to production lot. These inconsistencies coupled with the inherent differences between textile or wire braid, hard or soft wall, the presence or absence of an internal spiral wire and the differences in hose coverings make it difficult to establish hard and fast rules. Therefore, it is imperative that hose dimensions are accurately measured, assemblies are tested, and documentation is maintained. Visit dixonvalve.com/knowledge-center/interactive-tools/crimp-swage for the most current crimp recommendations

Hose ID	Part #	Hose OD		Crimp Diameter (± 0.005)	Crimp Length	% Reduction
		Fractional	Decimal			
1/2"	4PS4-WF	54/64"	0.844"	0.917"	1-1/4"	18.9
		55/64"	0.859"	0.929"	1-1/4"	18.9
		56/64"	0.875"	0.942"	1-1/4"	18.9
		57/64"	0.891"	0.954"	1-1/4"	19.0
		58/64"	0.906"	0.967"	1-1/4"	19.0
		59/64"	0.922"	0.980"	1-1/4"	19.0
		60/64"	0.938"	0.992"	1-1/4"	19.0
		61/64"	0.953"	1.005"	1-1/4"	19.0
		62/64"	0.969"	1.018"	1-1/4"	19.0
		63/64"	0.984"	1.030"	1-1/4"	19.0
		1"	1.000"	1.043"	1-1/4"	19.0
		1-1/64"	1.016"	1.056"	1-1/4"	19.0
		1-2/64"	1.031"	1.068"	1-1/4"	19.0
		3/4"	4PS6-WF	1-10/64"	1.156"	1.220"
1-11/64"	1.171"			1.235"	1-1/4"	18.0
1-12/64"	1.187"			1.245"	1-1/4"	18.7
1-13/64"	1.203"			1.260"	1-1/4"	18.1
1-14/64"	1.218"			1.270"	1-1/4"	18.8
1-15/64"	1.234"			1.285"	1-1/4"	18.2
1-16/64"	1.250"			1.295"	1-1/4"	18.8
1-17/64"	1.265"			1.310"	1-1/4"	18.4
1-18/64"	1.281"			1.320"	1-1/4"	18.8
1-19/64"	1.296"			1.335"	1-1/4"	18.5
1-20/64"	1.312"			1.345"	1-1/4"	19.0
1-21/64"	1.328"			1.360"	1-1/4"	18.5
1-22/64"	1.343"			1.370"	1-1/4"	19.0

Installation Guide

Procedure 2306

- Prepare the hose
- Visit dixonvalve.com/knowledge-center/interactive-tools/crimp-swage for the most current crimp recommendations
- Depending upon type of crimper, set crimp diameter on machine or select die cage and spacers to achieve required crimp diameter
- Measure the distance from the end of the ferrule to the stem collar. Place a mark (line) on the hose (from the hose end) corresponding with this distance
- Insert the coupling into the hose until the end of the ferrule is even with the line just placed on the hose.
- Mark the crimp length on the ferrule
- Insert the coupling through the crimper die segments until the line on the ferrule is at the end of the die segments. Jog the machine until the die segments lightly contact the ferrule. Adjust fitting, if necessary, to ensure line is at end of die segments
- With light pressure on hose to ensure stem collar is contacting ferrule, activate the crimper until desired crimp diameter has been achieved
- Reverse machine and remove the coupling from the die segments. Measure the crimp diameter with dial calipers or micrometer
- Test assembly if required

Dual-Lock Interchange Guide

Hose Barb with Locking Sleeve

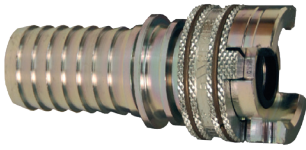

Size	Material	Dixon® Part #	Previous Part #	Campbell Part #	National Part #
3/8"	steel	4PS3	PHL6	TLH-38	HS6
1/2"	steel	4PS4	PHL8	TLH-2	HS8
3/4"	steel	4PS6	PHL12	TLH-3	HS12
	brass	4PS6-B	PHLB12	TLHB-3	HB12
	stainless	4PS6-S	PHL12SS	---	---
1"	steel	4PS8	PHL16	TLH-4	HS16
	brass	4PS8-B	PHLB16	---	---

Male Pipe Thread with Locking Sleeve

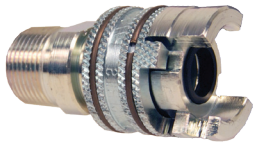

Size	Material	Dixon Part #	Previous Part #	Campbell Part #	National Part #
3/8"	steel	4PM3	PML6	TLM-38	MLS6
1/2"	steel	4PM4	PML8	TLM-2	MLS8
3/4"	steel	4PM6	PML12	TLM-3	MLS12
	stainless	4PM6-S	PML12SS	TLMSS-3	---

Female Pipe Thread with Locking Sleeve

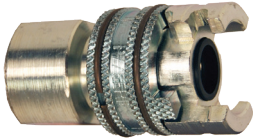

Size	Material	Dixon Part #	Previous Part #	Campbell Part #	National Part #
1/2"	steel	4PF4	PFL8	TLF-2	FLS8
3/4"	steel	4PF6	PFL12	TLF-3	FLS12
	stainless	4PF6-S	PFL12SS	TLFSS-3	---

Male Pipe Thread

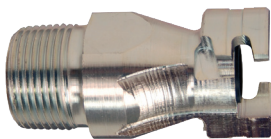

Size	Material	Dixon Part #	Previous Part #	Campbell Part #	National Part #
3/8"	steel	P4M3	PM6	TM-38	MS6
1/2"	steel	P4M4	PM8	TM-2	MS8
	brass	P4M4-B	PMB8	---	MB8
3/4"	steel	P4M6	PM12	TM-3	MS12
	brass	P4M6-B	PMB12	---	MB12
	stainless	P4M6-S	PM12SS	TMSS-3	---
1"	steel	P4M8	PM16	TM-4	MS16
	brass	P4M8-B	PMB16	---	---

Female Pipe Thread



Size	Material	Dixon Part #	Previous Part #	Campbell Part #	National Part #
3/8"	steel	P4F3	PF6	TF-38	FS6
1/2"	steel	P4F4	PF8	TF-2	FS8
	brass	P4F4-B	PFB8	---	FB8
3/4"	steel	P4F6	PF12	TF-3	FS12
	brass	P4F6-B	PFB12	---	FB12
	stainless	P4F6-S	PF12SS	TFSS-3	---
1"	steel	P4F8	PF16	TF-4	FS16
	brass	P4F8-B	PFB16	---	---

Dual-Lock Interchange Guide

Female Pipe Thread

Size	Material	Dixon Part #	Previous Part #	Campbell Part #	National Part #
3/8"	steel	P4F3	PF6	TF-38	FS6
1/2"	steel	P4F4	PF8	TF-2	FS8
	brass	P4F4-B	PFB8	---	FB8
3/4"	steel	P4F6	PF12	TF-3	FS12
	brass	P4F6-B	PFB12	---	FB12
	stainless	P4F6-S	PF12SS	TFSS-3	---
1"	steel	P4F8	PF16	TF-4	FS16
	brass	P4F8-B	PFB16	---	---



Hose Barb with Knurled Flanged Sleeve

Size	Material	Dixon Part #	Previous Part #	Campbell Part #	National Part #
3/8"	steel	4PS3-FS	PHL6FS	---	---
1/2"	steel	4PS4-FS	PHL8FS	---	---
3/4"	steel	4PS6-FS	PHL12FS	---	---

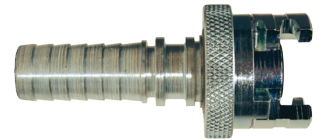

Male Pipe Thread with Knurled Flanged Sleeve

Size	Material	Dixon Part #	Previous Part #	Campbell Part #	National Part #
3/8"	steel	4PM3-FS	PML6FS	---	---
1/2"	steel	4PM4-FS	PML8FS	---	---
3/4"	steel	4PM6-FS	PML12FS	---	---

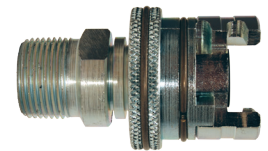

Male Pipe Thread with Knurled Flanged Sleeve

Size	Material	Dixon Part #	Previous Part #	Campbell Part #	National Part #
1/2"	steel	4PF4-FS	PFL8FS	---	---
3/4"	steel	4PF6-FS	PFL12FS	---	---

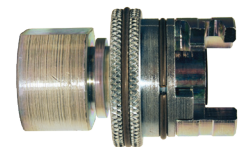

King Cable®

Application

- When hose, couplings, or clamps fail, or there is an accidental separation of the assembly, King safety cables minimize damage to equipment and injuries to operators.

Features

- Must be installed in the extended position (no slack)
- Cable reaches across hose fittings to provide standby safety for hose
- Spring-loaded loops in the cable ends open easily to pass over the couplings for a firm grip on the hose
- No tools needed - easy to install and remove
- Cables shipped with safety restraint labels attached
- Highly resistant to rust and corrosion
- Hose-to-hose or hose-to-rigid outlet

Materials

- For WB1, WB3, WA2, WA4, WSR1, WSR3, WSR2, WSR4, WSR1C, WB1C, WSR1E:
 - wire rope - galvanized carbon steel
 - ferrules - aluminum
 - springs - galvanized carbon steel
- For WB1SS, WB3SS, WA2SS, WA4SS, WSR1SS, WSR2SS, WSR3SS, WSR4SS:
 - wire rope - 304 stainless steel
 - ferrules - copper
 - springs - 304 stainless steel
- For WA2B:
 - wire rope - galvanized carbon steel
 - ferrules - copper
 - springs - galvanized carbon steel

Specification

- Maximum operating pressure: 200 PSI



Incorrect installation

Correct installation

Hose-to-Tool Service



Hose end

Tool end

Hose I.D.	Cable	Length	Maximum Working Pressure (PSI)	Steel Part #	Stainless Steel Part #
1/2" - 1-1/4"	1/8"	20-1/4"	200	WSR1	WSR1SS
1/2" - 2"	3/16"	28"	200	WSR3	WSR3SS
1-1/2" - 3"	1/4"	38"	200	WSR2	WSR2SS
4"	3/8"	44"	200	WSR4	WSR4SS

Hose-to-Hose Service



Hose end

Hose end

Hose I.D.	Cable	Length	Maximum Working Pressure (PSI)	Steel Part #	Stainless Steel Part #
1/2" - 1-1/4"	1/8"	20-1/4"	200	WB1	WB1SS
1/2" - 2"	3/16"	28"	200	WB3	WB3SS
1-1/2" - 3"	1/4"	38"	200	WA2	WA2SS
4"	3/8"	44"	200	WA4	WA4SS

⚠ WARNING

The constant vibration created by air tools, like air drills and pavement breakers, is destructive to air hose couplings, especially the quick-acting type. To provide protection against coupling breakage and related hazards, Dixon recommends the use of a whip hose. To construct a whip hose, connect one end of a short (3' to 10') air hose to the air tool using a 3500 type steel nipple. Connect the other end of the hose to the air supply using the standard quick-acting coupling. The heat-treated 3500 nipple will withstand vibration far better than the standard coupling and provide a safer connection. The whip hose should remain permanently connected to the tool.

Limited Warranty

DIXON VALVE AND COUPLING COMPANY, LLC (herein called "Dixon") warrants the products described herein and manufactured by Dixon to be free from defects in material and workmanship for a period of one (1) year from date of shipment by Dixon under normal use and service. Its sole obligation under this warranty being limited to repairing or replacing, as hereinafter provided, at its option any product found to Dixon's satisfaction to be defective upon examination by it, provided that such product shall be returned for inspection to Dixon's factory within three (3) months after discovery of the defect. The repair or replacement of defective products will be made without charge for parts or labor. This warranty shall not apply to: (a) parts or products not manufactured by Dixon, the warranty of such items being limited to the actual warranty extended to Dixon by its supplier; (b) any product that has been subject to abuse, negligence, accident, or misapplication; (c) any product altered or repaired by others than Dixon; and (d) to normal maintenance services and the replacement of service items (such as washers, gaskets, and lubricants) made in connection with such services. To the extent permitted by law, this limited warranty shall extend only to the buyer and any other person reasonably expected to use or consume the goods who is injured in person by any breach of the warranty. No action may be brought against Dixon for an alleged breach of warranty unless such action is instituted within one (1) year from the date the cause of action accrues. This limited warranty shall be construed and enforced to the fullest extent allowable by applicable law.

Other than the obligation of Dixon set forth herein, Dixon disclaims all warranties, express or implied, including but not limited to any implied warranties of merchantability or fitness for a particular purpose, and any other obligation or liability. The foregoing constitutes Dixon's sole obligation with respect to damages, whether direct, incidental, or consequential, resulting from the use or performance of the product.

Some products and sizes may be discontinued when stock is depleted or may require a minimum quantity for ordering.

About This Brochure and Our Products

This brochure is intended as a product offering. It is not a user or technical manual. Information in this brochure is subject to change without notice. We may modify product design and specification without notice and without any obligation to modify or substitute products previously purchased. All users and distributors of products sold through this brochure are strongly encouraged to contact Dixon with questions on use, compatibilities, coupling procedures, and life of product. Our full-time engineering and test staff are always available to recommend uses and to assist distributors and users with questions.



Safety



Safety logos, which appear throughout our catalog, are used as a reminder that the user should carefully review for the appropriateness of the product for the media, application, and environment in which it will be used.

NOTE: Because of the health hazards associated with contamination and lead content in drinking water systems, Dixon couplings, unless otherwise specifically approved, are not recommended for potable water service and should not be used in applications where drinking water will contact the wetted surfaces of the coupling.

All Dixon products are shipped in cartons with the following warning:

"WARNING: This product contains lead, a chemical known to the State of California to cause cancer and birth defects or other reproductive harm."

Trademarks

Delrin® and Zytel® are registered trademarks of DuPont Nemours and Company.

Kalrez® is a registered trademark of DuPont Dow Elastomers.

All other trademarks appearing in the Dixon illustrated price list are the property of their respective owners.

Copyright

Copyright © 2021 by Dixon Valve and Coupling, LLC

All rights reserved. This brochure is copyrighted material. Use, reproduction or copying of it by anyone other than Dixon® is strictly forbidden without its express written consent.

NOTE: Reasonable care has been taken in preparing this brochure. Dixon Valve & Coupling Company, LLC reserves the right to make corrections.

